



|   |                               |
|---|-------------------------------|
| CLIENT:<br>GERARD GANNON PROPERTIES                           |                               |
| PROJECT TITLE:<br>SHD APPLICATION<br>LANDS AT KILNAHUE, GOREY |                               |
| DRAWING TITLE:<br>Derelict Building Survey                    |                               |
| DATE: Mar 2022  | DRAWING NUMBER:<br>18-SHD 150 |
| SCALE: AS SHOWN   |                               |
| --info@connollyarchitects.ie -- 0863817731--                  |                               |

# Derelict Building Survey



# FLOOR PLAN

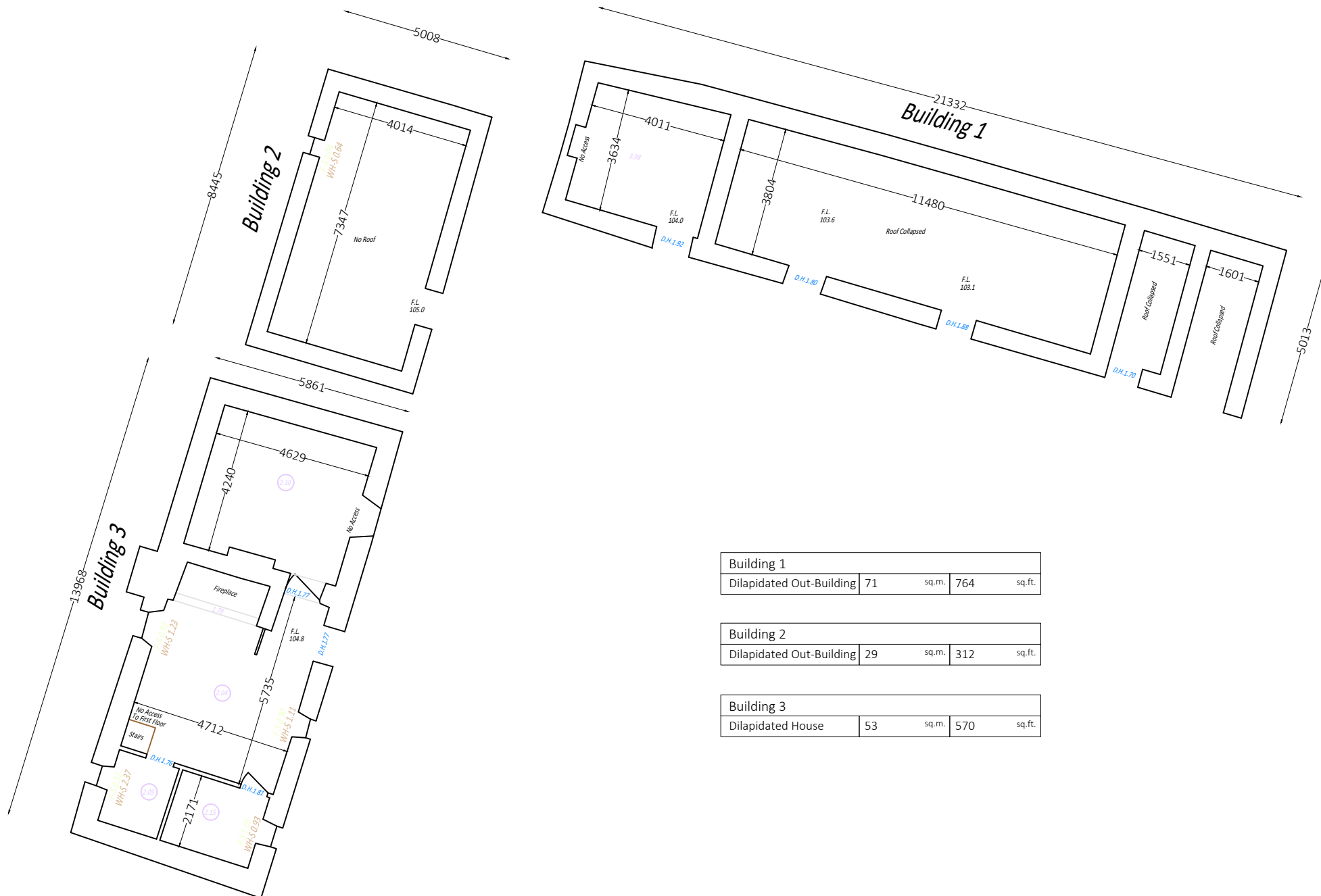
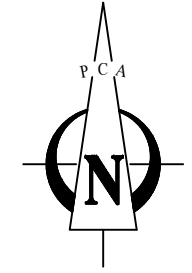

|                          |    |       |        |
|--------------------------|----|-------|--------|
| Building 1               |    |       |        |
| Dilapidated Out-Building | 71 | sq.m. | 764    |
|                          |    |       | sq.ft. |

|                          |    |       |        |
|--------------------------|----|-------|--------|
| Building 2               |    |       |        |
| Dilapidated Out-Building | 29 | sq.m. | 312    |
|                          |    |       | sq.ft. |

|                   |    |       |        |
|-------------------|----|-------|--------|
| Building 3        |    |       |        |
| Dilapidated House | 53 | sq.m. | 570    |
|                   |    |       | sq.ft. |

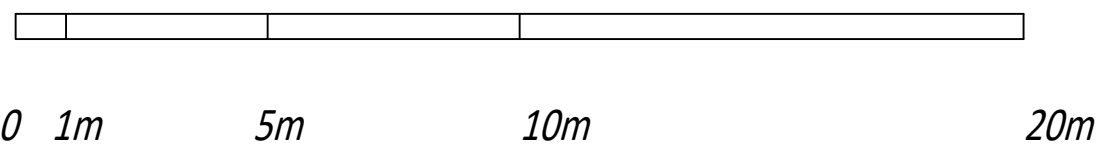

**Notes :**  
 This Survey was produced for original clients specification of time of instruction.  
 If the survey is to be used by any other parties, or for purposes other than those originally considered,  
 further details or higher accuracies may be required - Please contact PCA  
 PCA take no responsibility for additions made by third parties to survey.  
 Note : Accuracy of survey to plot scale

|   |   |  |   |
|---|---|--|---|
| PAUL CORRIGAN & ASSOCIATES<br>Hillcrest House, Hillcrest Road<br>Sandymount, Dublin 18<br>tel (+353 1) 2136300<br>fax (+353 1) 2136301<br>info@pca.ie | <b>KILNAHUE GOREY</b><br>ARCHAEOLOGICAL APPRAISAL |  | Job No. 1902000   |
|   | FLOOR PLAN  |  | Date 04/07/2019   |
|   | Scale   |  | Drawn   |
|   | Checked   |  | Checked   |
|   | Level: <i>Field Level</i>                         |  | * Accuracy and content of detail to be used on each of maps.<br>* Accuracy of this plan from aerial photography and ground<br>* Accuracy of this plan from ground survey and ground |

# ELEVATIONS - BUILDING 1

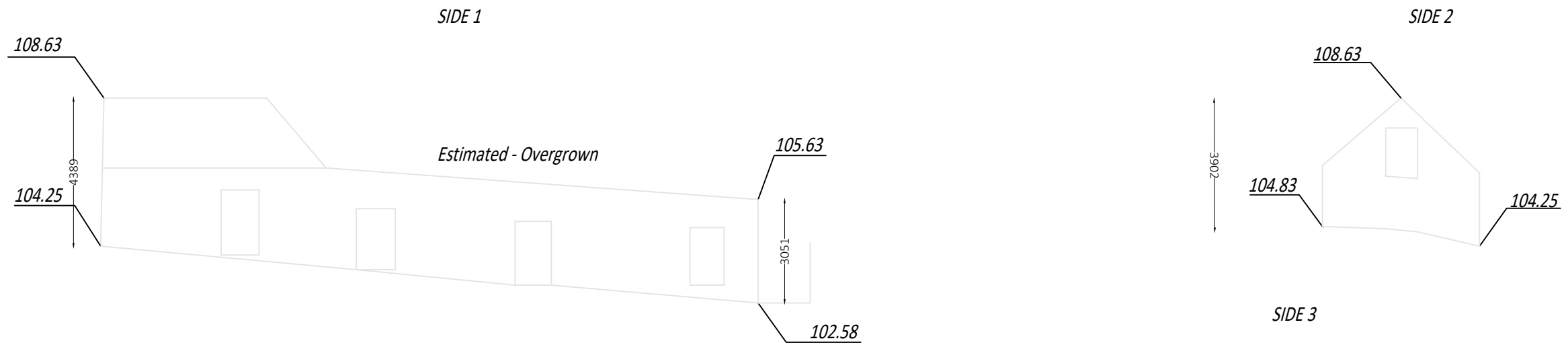

A.O.D 100.00m



A.O.D 100.00m

## KEY

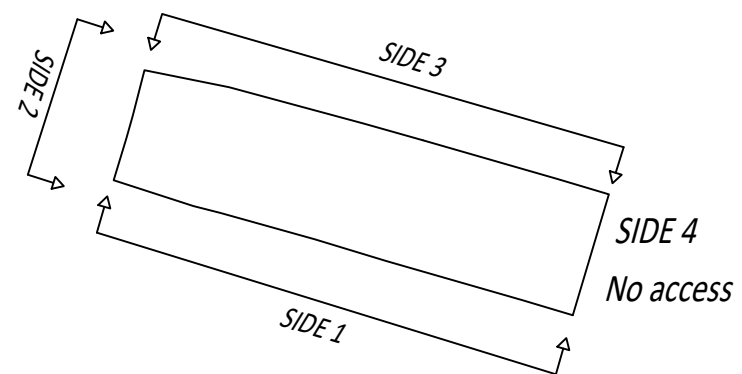

**Notes :**  
 This Survey was produced for original clients specification at time of instruction.  
 If the survey is to be used by any other parties, or for purposes other than those originally considered,  
 further details or higher accuracies may be required - Please contact PCA  
 PCA take no responsibility for additions made by third parties to survey.  
 Note : Accuracy of survey to plot scale

|  |   |  |   |                    |
|--|---|--|---|--------------------|
| PAUL CORRIGAN & ASSOCIATES<br>Hillcrest House, Hillcrest Road<br>Sandycove, Dublin 18<br>tel (+353 1) 2136300<br>fax (+353 1) 2136301<br>info@pca.ie | KILNAHUE GOREY<br>ARCHAEOLOGICAL APPRAISAL<br>ELEVATIONS - BUILDING 1 |  | Title:<br>KILNAHUE GOREY<br>ARCHAEOLOGICAL APPRAISAL<br>ELEVATIONS - BUILDING 1 | Job No.<br>1802019 |
|  |   |  | Date:<br>04/02/2019   |                    |
|  |   |  | Scale:<br>1:100   | Drawn:<br>JH       |
|  |   |  | Checked:<br>JH  |                    |

# ELEVATIONS - BUILDING 2

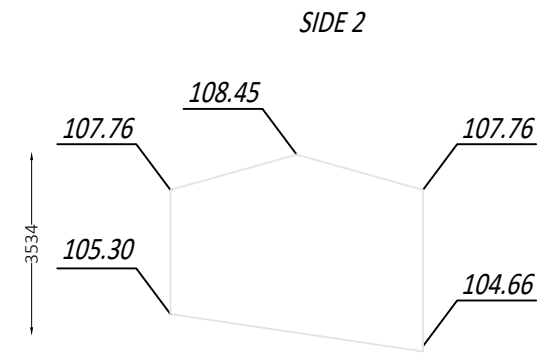
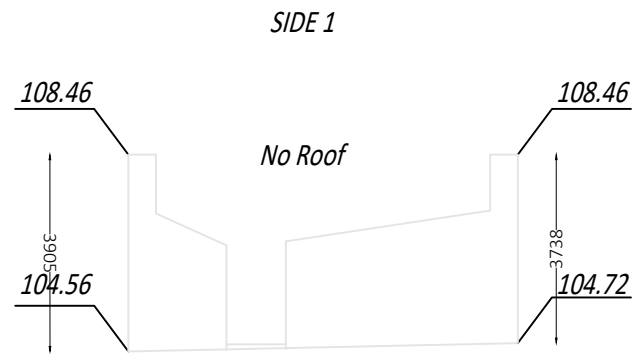

A.O.D 100.00m

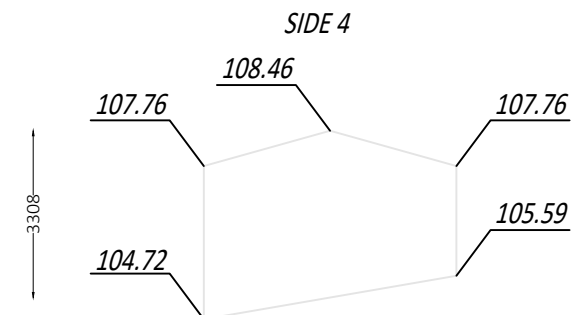

A.O.D 100.00m

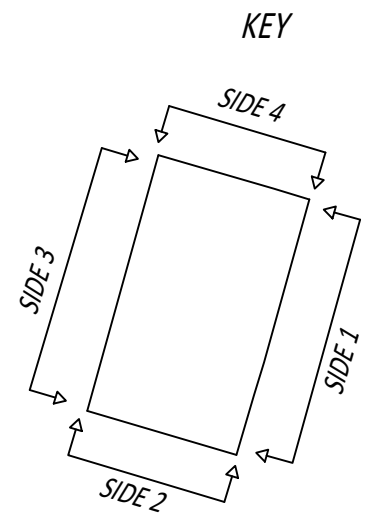

**Notes :**  
 This Survey was produced for original clients specification of time of instruction.  
 If the survey is to be used by any other parties, or for purposes other than those originally considered,  
 further details or higher accuracies may be required - Please contact PCA  
 PCA take no responsibility for additions made by third parties to survey.  
 Note : Accuracy of survey to plot scale

|   |   |   |         |            |
|---|---|---|---------|------------|
| PAUL CORRIGAN & ASSOCIATES<br>Hillcrest House, Hillcrest Road<br>Sandyford, Dublin 18<br>tel (+353 1) 2136300<br>fax (+353 1) 2136301<br>info@pcas.ie | KILNAHUE GOREY<br>ARCHAEOLOGICAL APPRAISAL<br>ELEVATIONS - BUILDING 2 | Notes:<br>DMM : <i>NA</i><br>Levels : <i>Mean Flood</i><br>* Accuracy and extent of work to be based on scale of map.<br>* The client shall be responsible for the accuracy of the data provided. | Job No. | PCAPP      |
|   |   |   | Date    | 11/11/2016 |
|   |   |   | Scale   |            |
|   |   |   | Drawn   |            |
|   |   |   | Checked |            |

# ELEVATIONS - BUILDING 3

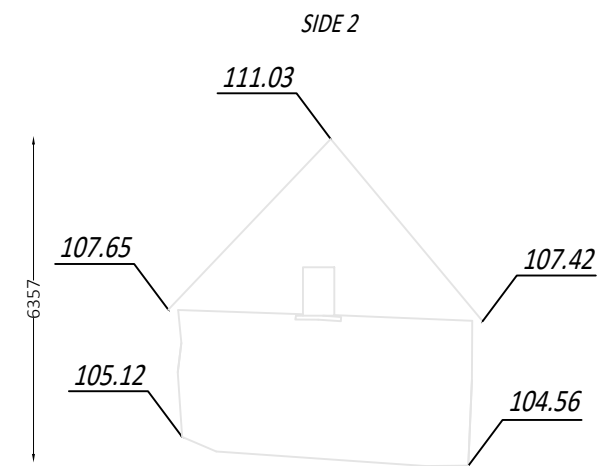
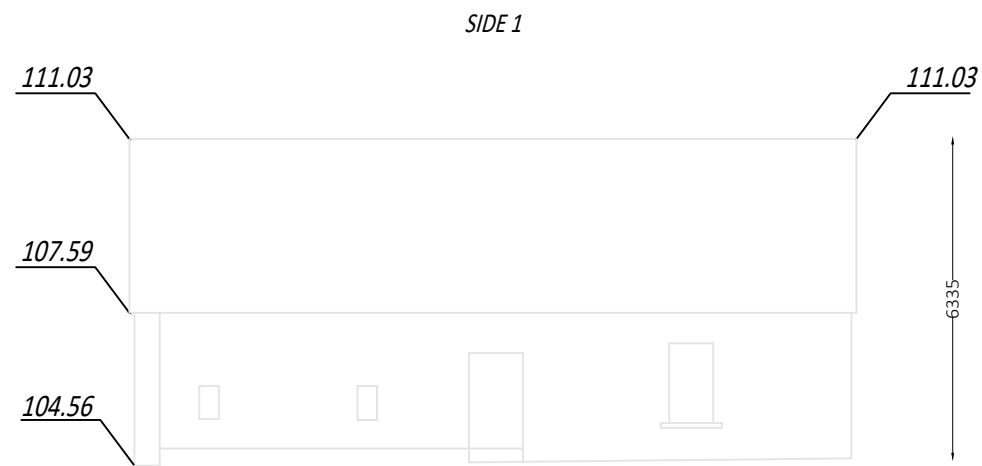

A.O.D 103.00m

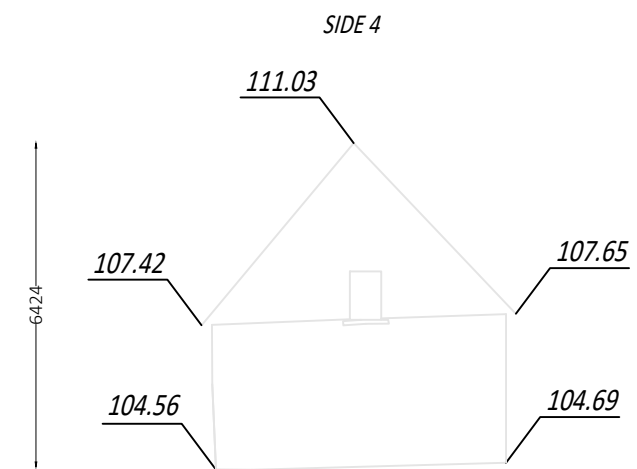

A.O.D 103.00m

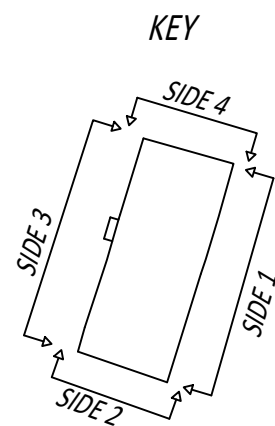

**Notes :**  
 This Survey was produced for original clients specification at time of instruction.  
 If the survey is to be used by any other parties, or for purposes other than those originally considered,  
 further details or higher accuracies may be required - Please contact PCA  
 PCA take no responsibility for additions made by third parties to survey.  
 Note : Accuracy of survey to plot scale

|   |   |                 |
|---|---|-----------------|
| PAUL CORRIGAN & ASSOCIATES<br>Hillcrest House, Hillcrest Road<br>Sandymount, Dublin 18<br>tel (+353 1) 2136300<br>fax (+353 1) 2136301<br>info@pca.ie | KILNAHUE GOREY<br>ARCHAEOLOGICAL APPRAISAL<br>ELEVATIONS - BUILDING 3 | Job No. PH00077 |
|   |   | Date 04/07/2018 |
|   |   | Scale 1:100     |
|   |   | Drawn PH        |
| Checked PH  | Title: <i>Kilnahue</i>  | Job No. PH00077 |
| Date 04/07/2018   | Scale 1:100   | Drawn PH        |
| Checked PH  | Title: <i>Kilnahue</i>  | Job No. PH00077 |

# SECTIONS

LONG SECTION A - A

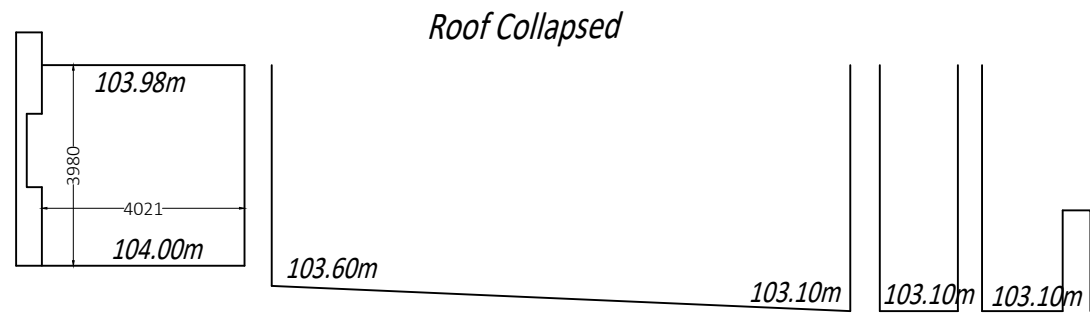

A.O.D 102.00 m

LONG SECTION B - B

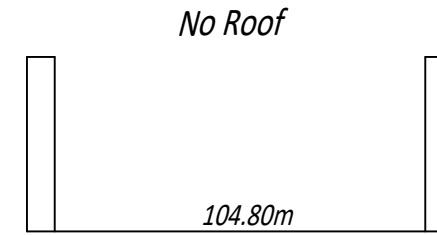

A.O.D 102.00 m

LONG SECTION C - C

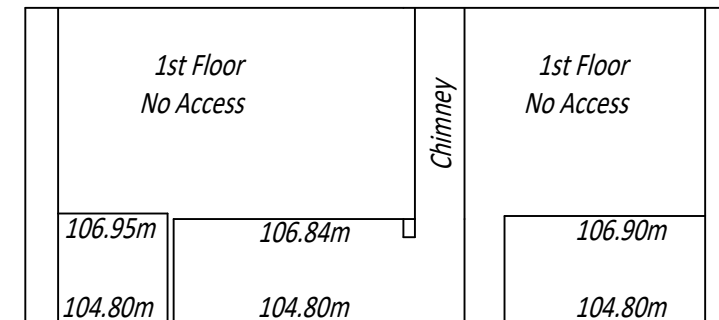

A.O.D 102.00 m

KEY

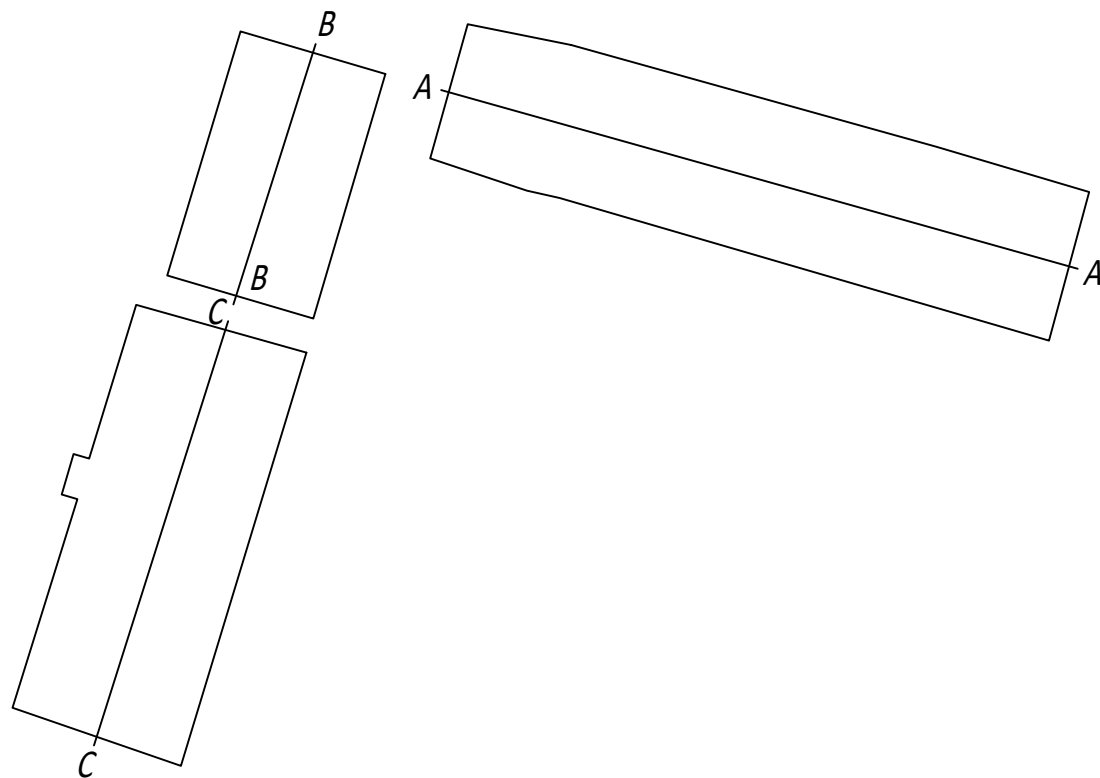

**Notes :**  
 This Survey was produced for original clients specification of time of instruction.  
 If the survey is to be used by any other parties, or for purposes other than those originally considered,  
 further details or higher accuracies may be required - Please contact PCA  
 PCA take no responsibility for additions made by third parties to survey.  
 Note : Accuracy of survey to plot scale

|  |  |          |          |
|--|--|----------|----------|
| PAUL CORRIGAN & ASSOCIATES<br>Hillcrest House, Hillcrest Road<br>Sandyford, Dublin 18<br>tel (+353 1) 2136300<br>fax (+353 1) 2136301<br>info@pca.ie | KILNAHUE GOREY<br>ARCHAEOLOGICAL APPRAISAL<br>SECTIONS | Title:   | Job No.  |
|  |  | Date:    | Date:    |
|  |  | Levels:  | Scale:   |
|  |  | Drawn:   | Checked: |
|  |  | Checked: | Checked: |